

Synthesis of Egyptian Rice Straw Composites

Manal Amin Ramadan

*Mechanical Engineering department, The Higher Technological Institute,
Tenth of Ramadan City, Egypt.
Email: manal.amin@hti.edu.eg*

Rice straw strands were used as strengthening fillers as a part of various polymers, six composites were set up by utilizing polypropylene (PP) and polyethylene (PE) as matrix with three proportion containing 40%, 50 %and 60% by weight rice straw. Composites were effectively prepared by extrusion. The samples were characterized by tensile tests, impact test, wear, hardness and scanning electron microscopy (SEM). The consequences of the mechanical properties demonstrates that rice straw can be utilized as an option support for polypropylene and polyethylene .It was shown that, hardness, impact strength and modulus of versatility increment with expanding the polymer proportion. Composites PP 40% weight rice straw has higher mechanical properties than the PE in the same sythesis. Scanning electron microscopy (SEM) was utilized to look at the structure of the break surface and to legitimize the variety of the deliberate mechanical properties.

1. Introduction

The usage of fillers from different sources into polypropylene (PP) has been an acknowledged course to accomplish improvement in material properties or cost sparing conceivable outcomes, or both [1–3].In the most recent 20 years, cellulose based plant fibers separated from biomass are encountering expanded interest as strengthening materials for polymer networks. Biofiber-strengthened composites have diversified their applications into items, for example, building materials and auxiliary parts for engine vehicles by supplanting the petroleum inferred customary fortifying materials [4-6].Properties.

Natural fibers are now considered as serious alternative to synthetic fibers used in various fields. The use of natural fibers as reinforcing materials in both thermoplastic and thermoset matrix composites provides positive environmental benefits with respect to ultimate disposability and best utilization of raw materials [7-10]. There are many factors that can influence the performance of natural fiber reinforced composites. Apart from the hydrophilic nature e of fiber, the properties of the natural fiber reinforced composites can also be influenced by fiber content amount of filler In general; high fiber content is required to achieve high performance of the composites. Therefore, the effect of fiber content on the properties of natural fiber reinforced composites is particularly significant. It is often observed that the increase in fiber loading leads to an

increase in tensile properties [11]. Another important factor that significantly influences the properties and interfacial characteristics of the composites is the processing parameters used. Therefore suitable processing techniques and parameters must be carefully selected in order to yield the optimum composite products. In order to improve the similarity and adhesion between wood-flours and thermoplastic matrices, several chemicals have been employed with maleated coupling agents and were found to be the most suitable for organic filler filled thermoplastic composites [11-12]. Talc is a crystalline form of magnesium silicate which when pure has the formula $Mg_3(Si_4O_{10})(OH)_2$; talc has a platy structure that gives it reinforcing properties in polymers [13-15]. The current study aims to process composites of rice straw fibers to evaluate their potential as reinforcing materials for thermoplastic composites. Chemical and mechanical pulping was used to generate fibers, surface morphology, and physical, and mechanical properties. Mechanical properties of 30% wheat straw fiber filled polypropylene (PP) composites were evaluated to investigate the reinforcing potential of the straw fibers. The objective of the study described in this article was to investigate the influence of matrix type (polypropylene, polyethylene), and their weight percent on mechanical properties, as well as morphologies of the rice straw reinforced composites.

2. Materials and Methods

2.1. Materials

Rice straw fibers (RCF) collected from farm residue. However, before use it is cleaned and cursed into small pieces by locally made shatter machine. After grinding the fibers were sieved through sieve (No. 14), diameter fibers are range from 1.25 to 0.85 mm while its length ranged from 2 to 5 mm. Matrixes were from Petro Rabigh Saudi Polypropylene (PP) with melt Index 12 g/10 min, density 0.9 g/cm³, and Polyethylene (PE) with Density 0.921 gm/cm³, melt Index 8.0g/10 min, melting temperature 122°C. Maleic anhydride with a melt index of 64 g/10 min was used as a coupling agent from Byk Kometra GmbH. Talc Density was 1.000 (g/cm³) Mean diameter 6.72 (µm) purchased from Green Egypt Industries'. Glycerol ester of saturated fatty acids (GTS) 50°C melting temperature was used as lubricant from Baerlocher. Iron Oxide with Density 3.4 gm/cm³ From natural pigment was used.

2.2. Methods

Definition of the blends and the abbreviations utilized for the individual blends arranged are given in Table 1. Materials were bolstered into the Expulsion line [BEIER] comprises of Conelike twin-screw extruder, Blending unit, Mold, Vacuum adjustment table, Cutter and Stacker. Model YF300 was utilized to process composites. Prior to the expulsion, the rice straw was dried at 100°C for 20 h to conform a dampness substance of 1–2%. The rice straw strands strengthened polymer composites were set up by altogether blending of the

materials, in a variable rate two shaft mechanical blender. In the wake of blending every one of the investigations were performed in Expulsion line [BEIER].The barrel temperatures of the extruder were controlled at 164°C, 178 °C, 175°C, 179°C, and 188°C from zones 1 to 5, separately. The screw pace was 300 rpm and the melt weight was around 30 bars .The removes were cooled by water. The granules were infusion formed utilizing infusion shaping die. The temperature utilized for infusion shaped examples was 190°C from bolstering zone to bite the dust zone. The outcome tests were 150 ×20 mm cross segment and 1 m length.

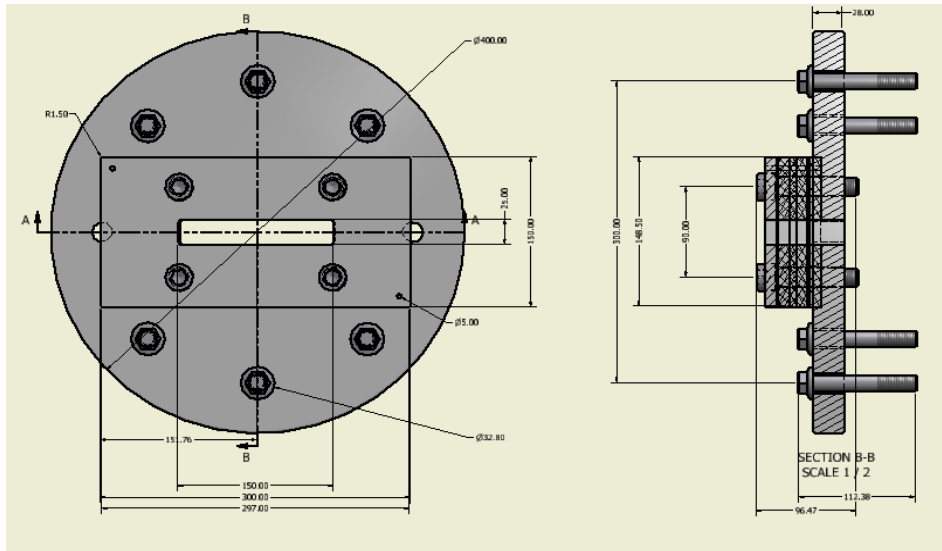

Fig. (1): the extrusion die.

Table (1): Material formulations used to prepare composites.

Composite name	Composition of (wt%)						
	(PP)	(PE)	Talc	pigmant	coupling agent	(GTS)	RSF
PP1	37	0	1.5	0.5	0.5	0.5	60
PP2	47	0	1.5	0.5	0.5	0.5	50
PP3	57	0	1.5	0.5	0.5	0.5	40
PE1	0	37	1.5	0.5	0.5	0.5	60
PE2	0	47	1.5	0.5	0.5	0.5	50
PE3	0	57	1.5	0.5	0.5	0.5	40

2.2. Testing and Characterization

Testing and characterization of the composites was performed on samples taken from the injection molded plates. The tensile of the specimens were measured using Galdabiny 20 universal testing machine. The tensile tests refer to ASTM D638. The tensile test samples were tested with a cross head speed of 10 mm/min. A pendulum Zwick impact tester (model 1446) was used for the impact

test. Every one of the specimens were scored in the focal point of one longitudinal side according to ASTM D256. At least five replicate samples for each formulation were tested. Wear abrasion resistance was evaluated by using pin on disc technique at load 0.9N to the composites through 15 minutes. The SEM of fracture surface of tensile, and impact pieces were studied using by scanning electron microscopy (SEM) with a Joel JXA-840 A. The hardness of the composites was measured utilizing a Rockwell Hardness Testing Machine according to ASTM D785-98 [16].

3. Results and Discussion

3.1. Tensile Properties

The tensile strength of the pp, and PE composites rice straw strengthened is appeared in Fig. (1). For all composites, the elasticity diminished with expanding weight percent of rice straw [17,18] which is as per different scientists. As the rice straw expanded, the powerless interfacial territory between the fiber and network expanded, which hence diminished the pliable strength. It is found that the rigidity expanded roughly 12–27% over the PP rice straw composites, while the addition was 27–35% over PE composites. The scope of the rigidity got in the ebb and flow work is 20–40 MPa, which is lower than the extent acquired in past exploration (23–55 MPa) utilizing the same matrix and fiber material [17,18]. This could be because of the utilization of various compatibiliser and modifier in past exploration.

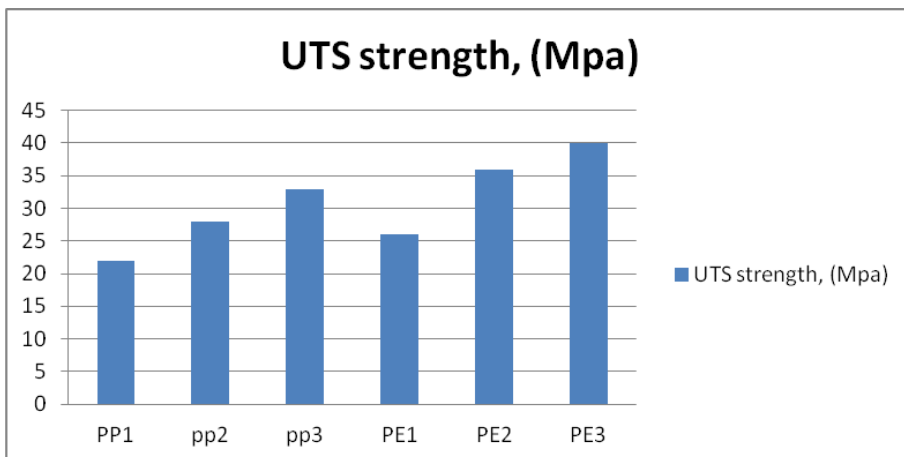

Fig.(1): Tensile strength of PP and PE reinforced with differ rent weight percent of rice straw composites .

3.2. Modulus of Elasticity

The effect of rice straw/polymer rate on the elasticity modulus of the rice straw fiber/poly propylene and rice straw fiber poly ethylene composites prepared under the same conditions The outcomes, demonstrate that the modulus of elasticity of these composites are forcefully expanded up to 18 % of polymer,

past, these rate, modulus of elasticity of these composites marginally increment with the expansion of the polymer content. Additionally, for a given rice straw fiber/polymer proportion, the modulus of elasticity of rice straw fiber/polymer proportion, the modulus of elasticity of rice straw fiber/poly ethylene composite is higher when contrasted with its estimations of rice straw fiber/poly propylene composite. The poor scattering of the filaments and decreased interfacial bond to the polymer lattice may clarify this diminishment since; the powerful exchange of anxiety in the middle of network and fiber requires a satisfactory interfacial bending [19,20]. In continuous fiber reinforced plastics the fiber decides the essential property of the composite. The function of the resin is permitting the fiber to build up its maximum capacity by exchanging the anxiety starting with one fiber then onto the next. The anxiety is exchanged from the matrix to the fibers through the interfacial shear stress.

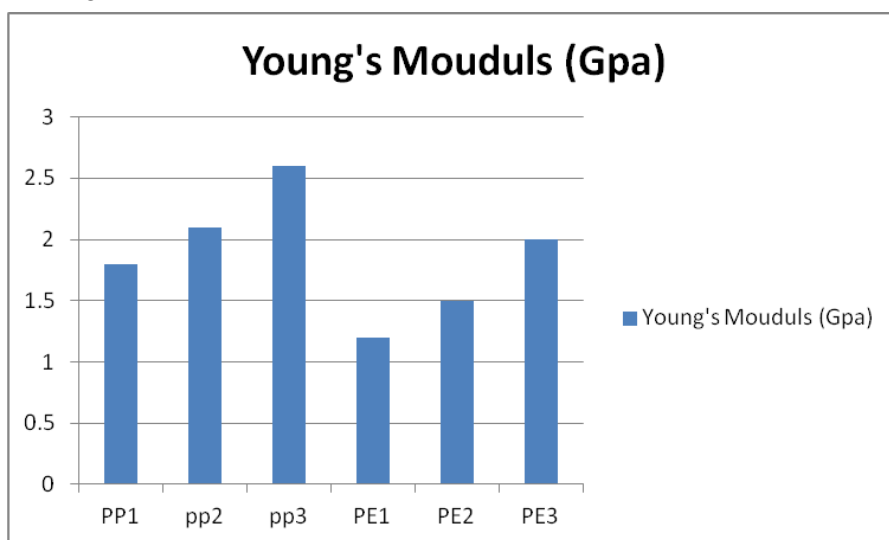

Fig.(2): Young's Modulus of PP, and PE reinforced with differ rent weight percent of rice straw composites.

3.4. Impact Strength Results

The impact of rice straw/polymer proportions on the impact strength values of rice straw fiber/poly propylene and rice straw fiber/poly ethylene composites appeared in (Fig. 3).The experimental results showed that, the effect impact strength of the two composites increments with expanding the polymer rate in the blend sythesis. It was additionally watched that for a given fiber/polymer proportion, the effect impact strength of the rice straw/poly propylene composite are higher than that its impact of rice straw/poly ethylene composite. It has been accounted for that high fiber content builds the probability of fiber agglomeration which results in locales of anxiety focus requiring less vitality for break engendering [21]. As introduced in Fig. (3), impact strength of all composites increment with fiber expanding. This outcome recommends that

the fiber was equipped for engrossing vitality in light of solid interfacial holding between the fiber and matrix. Any upgrade in strength because of the nearness of these normal strands, must depend upon the way of the fiber matrix bond or the inborn sturdiness of the filaments themselves. The nearness of a powerless fiber-network interface can represent a sturdiness composite that is itself shaped from two weak stages. The opening up of another surface at the interface results in the ingestion vitality, preoccupation of splits, thus drives [22]. The way of the interface area is in this way of amazing significance in deciding the durability of the composite. On the off chance that the fiber matrix interfacial quality is too low, then poor anxiety exchange happens, and a frail composite results. On the other hand, a solid interfacial bond considers extremely proficient anxiety exchange yet delivers composite showing poor strength properties [18]. As per the later talking, with an expanding of the polymer rate in the blend arrangement, both durability and interfacial quality are significantly enhanced, as a consequences of the development of concoction securities between the rice straw surface and the polymer latex amid the expulsion procedure of the blend organization. These are connected with significantly upgrade of the effect quality of the composite. The utilization of poly propylene polymer demonstrated a higher estimation of the effect quality of the rice straw poly propylene polymer when contrasted with the rice straw/poly ethylene polymer. The clarification for this situation might be identified with the nearness of the hydroxyl groups in poly propylene polymer structure these are prompting an arrangement of hydrogen synthetic bonds between the poly propylene and the rice straw fiber's surface, and thus, an upgrade of the sturdiness and interfacial quality of rice straw/poly propylene composite.

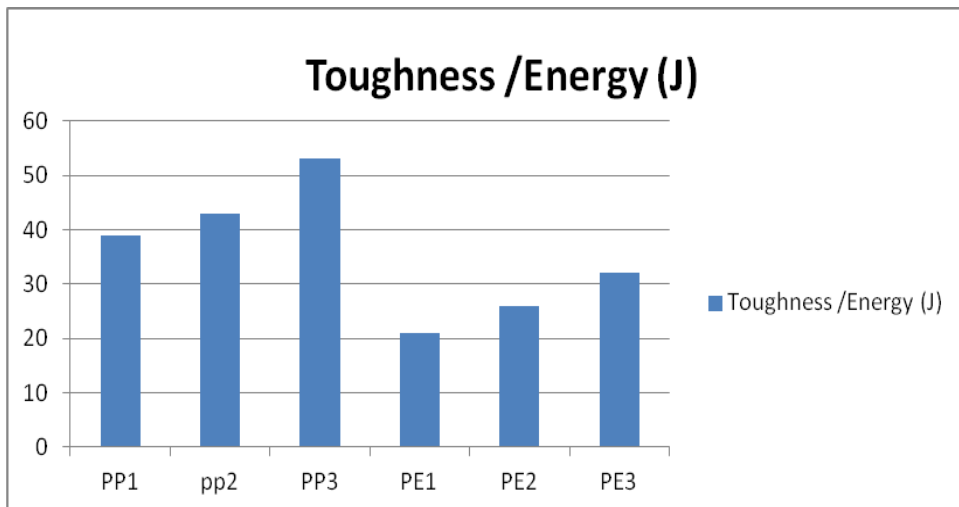

Fig. (3): Toughness energy for composites

3.5. Wear Results

The outcomes acquired for the wear rate of the rice straw fiber/polypropylene and rice straw fiber/polyethylene composites are shown in Fig.4. From the outcomes there is appreciable reduction in the wear rate of the rice straw fiber/poly ethylene composites with the expansion of the rice straw fiber as support. wear rate for rice straw fiber/poly propylene ranges from 0.1–0.6 g, while the qualities for rice straw fiber/poly ethylene composites were in the request of 0.2– 0.8 g at 60 wt% rice straw fiber and 0.1–0.6 g at 40 wt% rice straw fiber individually. The decrease in wear rate of the composites be credited to higher load bearing capacity of hard reinforcing material and better interfacial security between the molecule and the matrix reducing the possibility of particle pull out which may bring about higher wear. The wear resistance of the composites is enhanced by averting direct contacts that induce subsurface deformation. The expansion of rice straw fiber enhances the imperviousness to seizure. The rice straw fiber permits extensive thermal softening impacts without having adverse affecting the wear behaviour. The reinforcement likewise causes higher hardness and less coefficient of thermal expansion of the poly propylene matrix. The presence of the rice straw fiber gives a higher thermal stability, expanded scraped area and sliding wear resistance at high load and postpones the transition from mild to severe wear

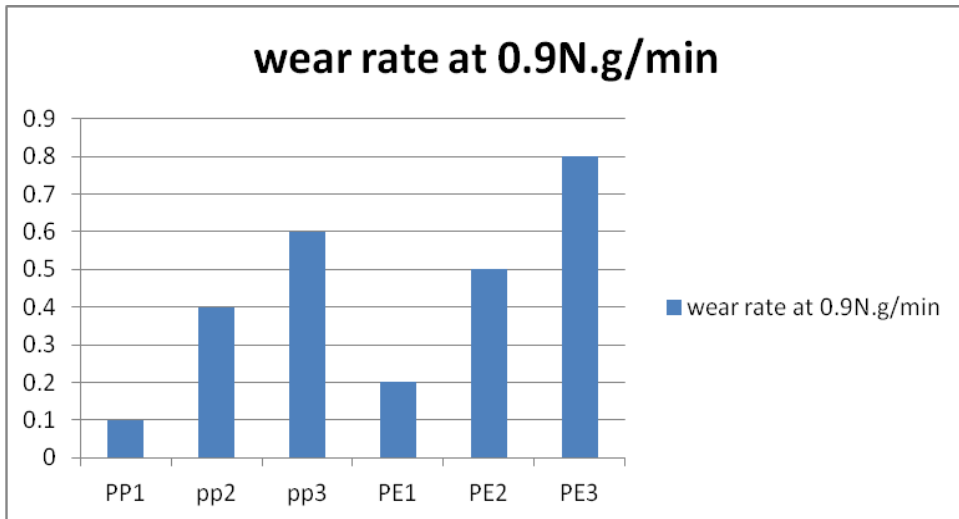

Fig.(4): The wear behavior of the composites

3.6. Hardness Results

Figure (5) demonstrates the hardness of different fabricated composites with various rice straw weight percent. The normal hardness expanded with expanding of rice straw weight percent. This is because of the diminishing of flexibility and expansion of stiffness the respective composites. The rice straw fiber/poly propylene composites yielded much higher hardness contrasted with

rice straw fiber/poly ethylene composites. This could be credited to both scattering of the fiber into the matrix with minimization of voids and more grounded interfacial holding between the fiber and matrix.

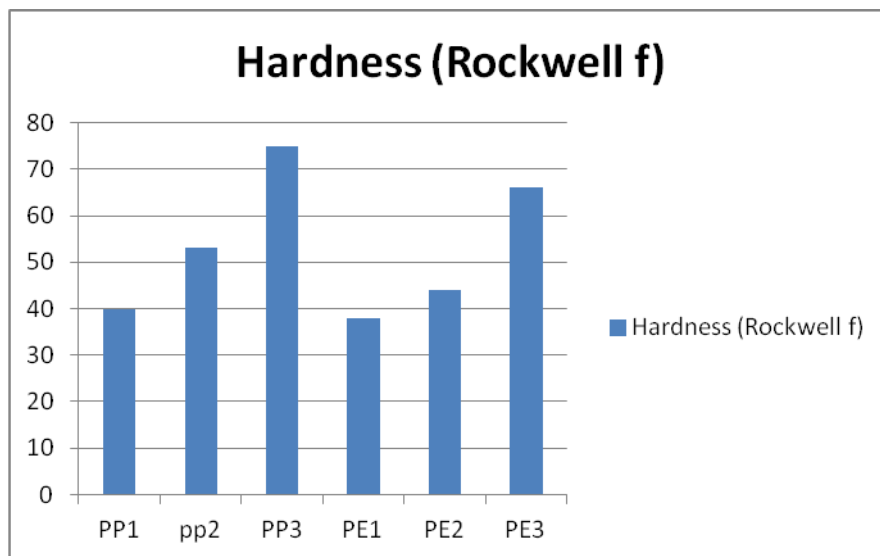

Fig.(5): Variation of hardness of different composites.

3.6. SEM Morphology

SEM micrographs of the tensile fracture surfaces of the rice straw fiber/poly propylene composites [PP2], rice straw fiber/poly ethylene composites [PE2], and 40% rice straw strengthened PP3 composites are appeared in Figs. (6–8), individually. The SEM image of the rice straw fiber/poly propylene composites [PP3] (Fig. 6) indicates agglomeration of rice straw fiber in the PP matrix. This element proposes feeble interfacial holding between the fiber and matrix. Then again, rice straw fiber/poly ethylene composites [PE3] (Fig. 7) indicate better scattering of the fiber into the matrix. This brought about a superior interfacial holding between the fiber and matrix. The best scattering and interfacial holding is seen on account of rice straw fiber/poly propylene composites[PP3] (Fig. 8). As plainly found in the micrograph, agglomeration of rice straw fiber has been considerably decreased in the composite. In light of the rice straw fiber, 40% fiber strengthened composites had the ideal arrangement of mechanical properties. At the point when fiber substance was expanded to half, the flexural and impact strength diminished. This might be credited to the augmentation of the intermolecular fascination in the middle of fibers and PE contrasted with fiber and PP matrix. The holding between the PP grid and fiber must be enhanced with a specific end goal to have better mechanical properties at higher fiber content. This might be accomplished by concoction modification of the PP matrix, along these lines changing its hydrophobic nature to hydrophilic nature.

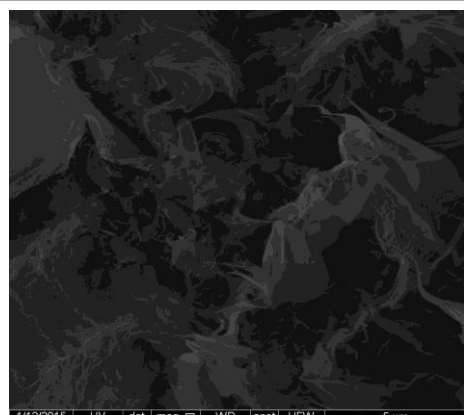

Fig.(6): SEM micrograph of 50% rice straw reinforced PP2 composite.

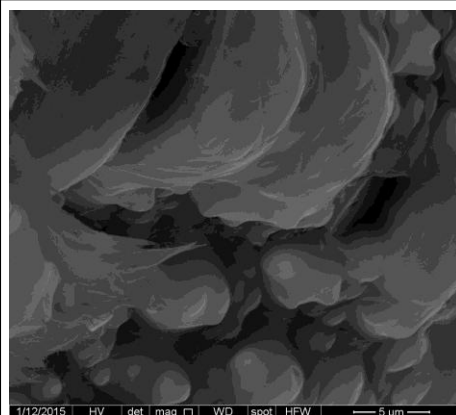

Fig.(7): SEM micrograph of 50% rice straw reinforced PE2 composite.

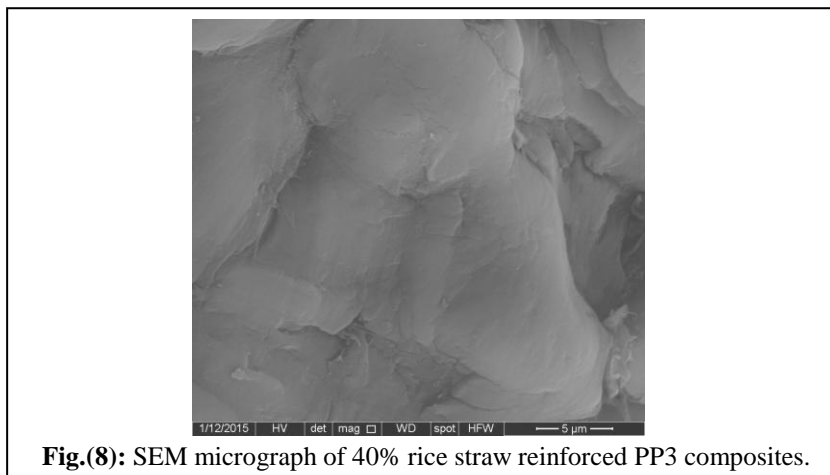

Fig.(8): SEM micrograph of 40% rice straw reinforced PP3 composites.

4. Conclusion

In the present work, rice straw reinforced PP, and PE composites were fabricated utilizing single extruder and injection molding method. Significant impact of the rice straw weight percent and sort of matrix on the mechanical properties is observed. Taking after conclusion can be drawn from the experimental results of this study:

- 1- a definitive elasticity of the composites diminished with an expansion in the rice straw weight percent. In any case, there was an expansion in the elasticity of the 27% of pp composites contrasted with the PE composites.
- 2- The Young's modulus, impact strength, and hardness of the composites expanded with a decline in the rice straw weight percent. Nonetheless, the rice straw strengthened PE composites had lower impact strength contrasted with the rice straw fortified PP composites.

- 3- The wear rate of the composites diminished with an expansion in the rice straw weight percent. Notwithstanding, the rice straw fortified PE composites had higher wear rate contrasted with the rice straw strengthened PP composites.
- 4- It was recommend that the 40% rice straw fortified PP composites had the ideal arrangement of mechanical properties in correlation with other fabricated composites.
- 5- The present composites are adequate, and absolutely suitable for commercial exploitation.

References

1. G. Pritchard, in: G. Pritchard (Ed.), *Plastics Additives*, Chapman and Hall, London, 241 (1998).
2. H. S. Yang, H. J. Kim, H. J. Park, B. J. Lee, T. S. Dan Wang, *Composite Structures*, **77**, 45 (2005).
3. N. Sharma, L.P. Chang, Y.L. Chu, H. Ismail, U.S. Ishiaku, Z.A.M. Ishak, *Polym. Degrad. Stab.* **71**, 381 (2001).
4. M. Pervaiz, M. Sain, *SAE Paper*, **01**, 0729 (2004).
5. S. Panthapulakkal, S. Law, M. Sain, *SAE Paper*, **01**, 0014. (2004).
6. Wolcott, M.P., Smith, P.M., *Toronto*, ON, **1**, 10. (2004).
7. G. S. Chauhan, S. S. Bhatt, I. Kaur, A. S. Singha, and B.S.J. Kaith, *Polym. Degrad. & Stability*, **69**, 261 (2000).
8. A. S. Singha, B. S. Kaith, Ashish Chauhan and B. N. Misra, *Polym. Mater*, **23**, 3456 (2006J).
9. A. S. Singha, and K. Thakur Vijay, *Iran. Polym. J.*, **17**, 541 (2008b).
10. B. S. Kaith, and Kalia Susheel, *Int. J. Polym. Anal. & Charact.*, **12**, 401 (2007).
11. Chris De Armit, Kevin Breese, improved thermoplastic composites by optimised surface treatment of the mineral fillers Institute for Surface Chemistry © Chris DeArmitt and Kevin Breese, **1**, 65 (2009).
12. Pan Ming-Zhu, Mei Chang-Tong, Zhou Xu-Bing, Pu Yun-Lei, *Journal of Applied Polymer Science*, **121**, 2900 (2011).
13. Tiina Huuhilo, Ossi Martikka Svetlana, Butylina Timo Kärk, Mineral fillers for wood– plastic composites, *Wood Material Science and Engineering*, **1**, 34 (2010).
14. R.N. Rothon, *Mineral Fillers in Thermoplastics Filler Manufacture and Characterization*, *Advances in Polymer Science*, Springer-Verlag Berlin Heidelberg (1999), Vol.139.
15. I. Lerner, High durability and low maintenance boost WPC prospects, *Chemical Market Reporter*, **264**, 12 (2003).
16. ASTM Standard D 785-98. Standard test method for rockwell hardness of plastics and electrical insulating materials. In: *Annual book of ASTM standard*, vol. **08**, 01. (2002).

17. M.S. Jamil, I. Ahmed, I. Abdullah, *J. Poly Res.*, **13**, 315 (2006).
18. N. Chand, U.K. Dwivedi, *Wear*, **261**, 1057 (2006).
19. T.T.L Doan, S.L. Gao, E. Mader., *Comp Sci Tech*, **66**, 952 (2006).
20. L. M. Matuana, C. B. Park, and J. J. Balatinez in “*Cellular and Microcellular Materials*” (V. Kumar and K. A. Sealer, Eds.), ASME, New York, **76**, 1 (1996).
21. L. M. Matuana, G. B. Park, and J. J. Balatenez, *J. Vinyl Addit. Technol.*, **3**, 265 (1997).
22. A. Karmakar, S.S. Chauhan, J.M. Modak, M. Chanda, *Mechanical properties of wood-fiber reinforced polypropylene composites. Comp., A* **38**, 227 (2007).
23. M. M. Younes, H. A. Abdel-Rahman, W. Orabi, and M. R. Ismail, *Polym. Compos.*, **29**, 768 (2008).